



MMBT3906

PNP GENERAL PURPOSE SWITCHING TRANSISTOR

VOLTAGE 40 Volts **POWER** 225 mWatts **SOT-23** Unit: inch (mm)

FEATURES

- PNP epitaxial silicon, planar design
- Collector-emitter voltage $V_{CE} = -40V$
- Collector current $I_C = -200mA$
- In compliance with EU RoHS 2002/95/EC directives

MECHANICAL DATA

Case: SOT-23, Plastic

Terminals: Solderable per MIL-STD-750, Method 2026

Approx. Weight: 0.008 gram

Marking: S2A

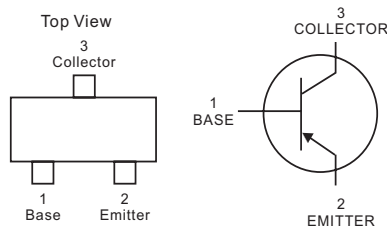
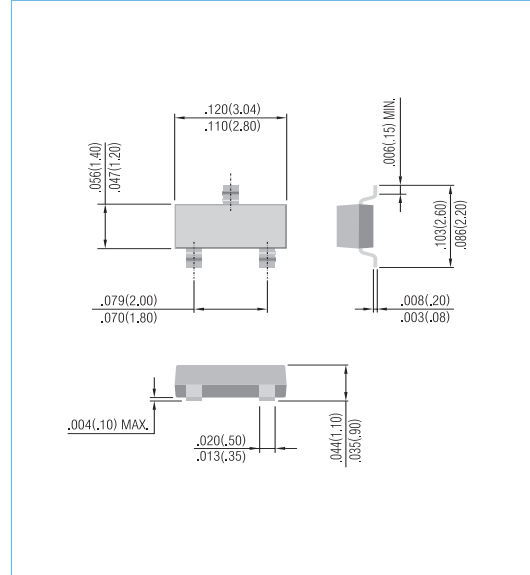

ABSOLUTE RATINGS

PARAMETER	Symbol	Value	Units
Collector - Emitter Voltage	V_{CEO}	-40	V
Collector - Base Voltage	V_{CBO}	-40	V
Emitter - Base Voltage	V_{EBO}	-5.0	V
Collector Current - Continuous	I_C	-200	mA

THERMAL CHARACTERISTICS

PARAMETER	Symbol	Value	Units
Max Power Dissipation (Note 1)	P_{TOT}	225	mW
Thermal Resistance , Junction to Ambient	$R_{\theta JA}$	556	$^{\circ}C/W$
Junction Temperature	T_J	-55 to 150	$^{\circ}C$
Storage Temperature	T_{STG}	-55 to 150	$^{\circ}C$

Note 1: Transistor mounted on FR-5 board 1.0 x 0.75 x 0.062 in.



MMBT3906

ELECTRICAL CHARACTERISTICS

PARAMETER	Symbol	Test Condition	MIN.	TYP.	MAX.	Units
Collector - Emitter Breakdown Voltage	$V_{(BR)CEO}$	$I_C = -1.0\text{mA}, I_B = 0$	-40	-	-	V
Collector - Base Breakdown Voltage	$V_{(BR)CBO}$	$I_C = -10\mu\text{A}, I_E = 0$	-40	-	-	V
Emitter - Base Breakdown Voltage	$V_{(BR)EBO}$	$I_E = -10\mu\text{A}, I_C = 0$	-5.0	-	-	V
Base Cutoff Current	I_{BL}	$V_{CE} = -30\text{V}, V_{EB} = -3.0\text{V}$	-	-	-50	nA
Collector Cutoff Current	I_{CEX}	$V_{CE} = -30\text{V}, V_{EB} = -3.0\text{V}$	-	-	-50	nA
DC Current Gain (Note 2)	h_{FE}	$I_C = -0.1\text{mA}, V_{CE} = -1.0\text{V}$ $I_C = -1.0\text{mA}, V_{CE} = -1.0\text{V}$ $I_C = -10\text{mA}, V_{CE} = -1.0\text{V}$ $I_C = -50\text{mA}, V_{CE} = -1.0\text{V}$ $I_C = -100\text{mA}, V_{CE} = -1.0\text{V}$	60 80 100 60 30	- - - - -	- - 300 - -	-
Collector - Emitter Saturation Voltage (Note 2)	$V_{CE(SAT)}$	$I_C = -10\text{mA}, I_B = -1.0\text{mA}$ $I_C = -50\text{mA}, I_B = -5.0\text{mA}$	-	-	-0.25 -0.4	V
Base - Emitter Saturation Voltage (Note 2)	$V_{BE(SAT)}$	$I_C = -10\text{mA}, I_B = -1.0\text{mA}$ $I_C = -50\text{mA}, I_B = -5.0\text{mA}$	-0.65 -	- -	-0.85 -0.95	V
Collector - Base Capacitance	C_{CBO}	$V_{CB} = -5\text{V}, I_E = 0, f = 1\text{MHz}$	-	-	4.5	pF
Emitter - Base Capacitance	C_{EBO}	$V_{EB} = -0.5\text{V}, I_C = 0, f = 1\text{MHz}$	-	-	10	pF
Delay Time	t_d	$V_{CC} = -3\text{V}, V_{BE} = -0.5\text{V}, I_C = -10\text{mA}, I_B = -1.0\text{mA}$	-	-	35	ns
Rise Time	t_r	$V_{CC} = -3\text{V}, V_{BE} = -0.5\text{V}, I_C = -10\text{mA}, I_B = -1.0\text{mA}$	-	-	35	ns
Storage Time	t_s	$V_{CC} = -3\text{V}, I_C = -10\text{mA}, I_{B1} = I_{B2} = -1.0\text{mA}$	-	-	225	ns
Fall Time	t_f	$V_{CC} = -3\text{V}, I_C = -10\text{mA}, I_{B1} = I_{B2} = -1.0\text{mA}$	-	-	75	ns

Note 2: Pulse Test: Pulse Width < 300 us, Duty Cycle < 2.0%.

SWITCHING TIME EQUIVALENT TEST CIRCUITS

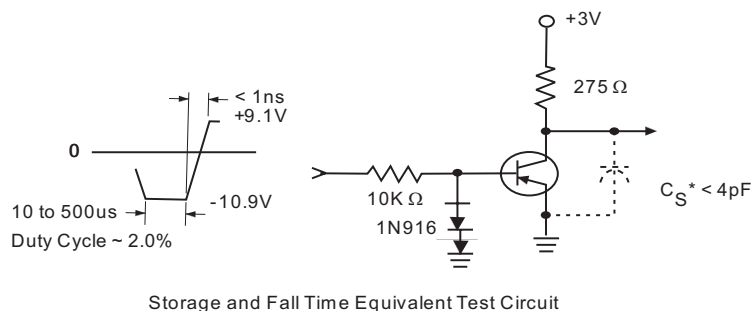
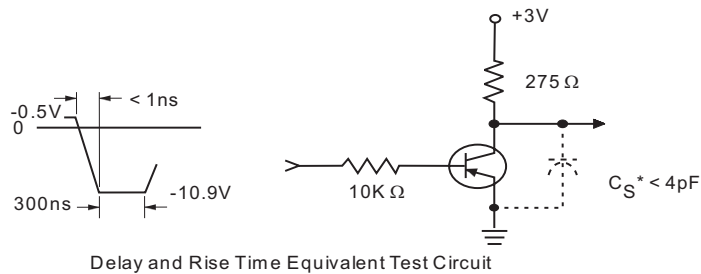



ELECTRICAL CHARACTERISTICS CURVE

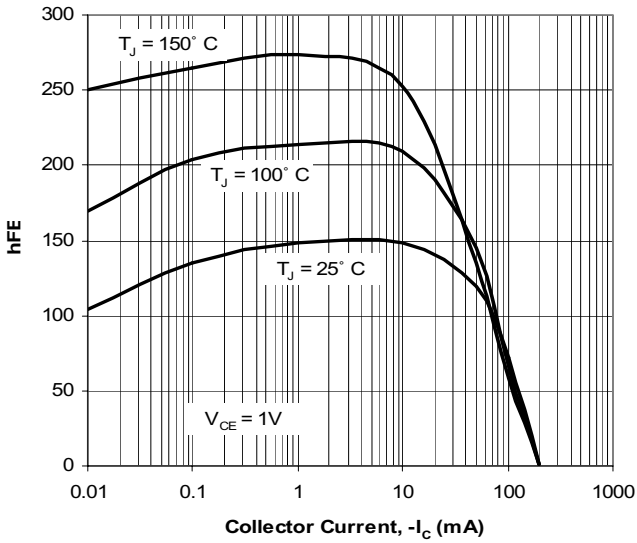

Fig. 1. Typical h_{FE} vs. Collector Current

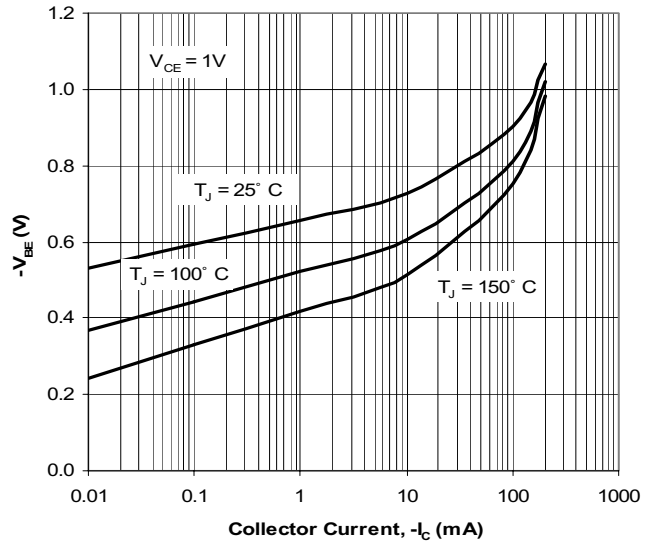

Fig. 2. Typical V_{BE} vs. Collector Current

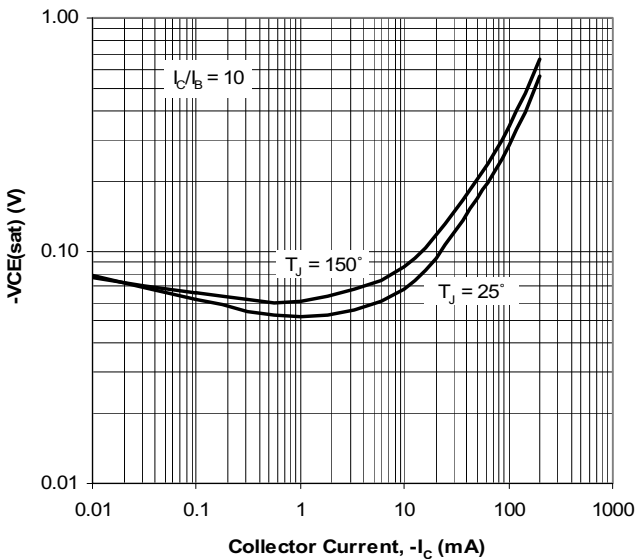

Fig. 3. Typical $V_{CE(sat)}$ vs. Collector Current

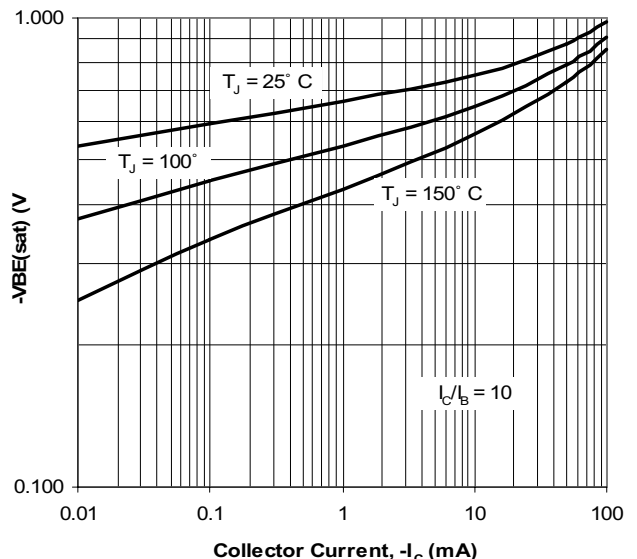

Fig. 4. Typical $V_{BE(sat)}$ vs. Collector Current

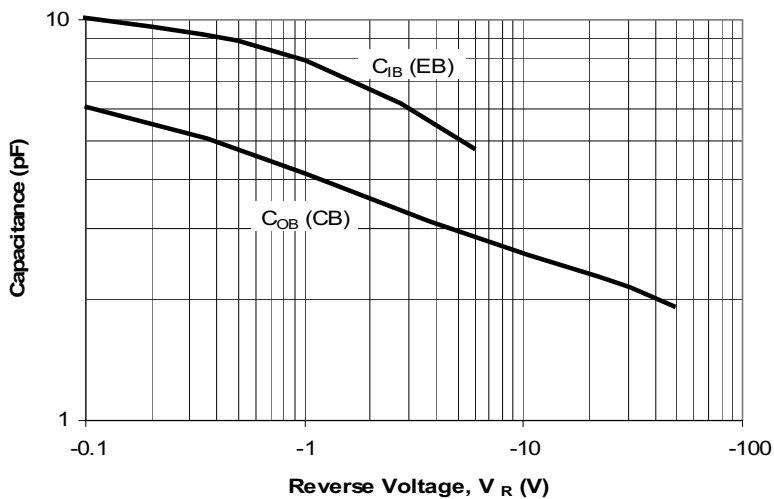
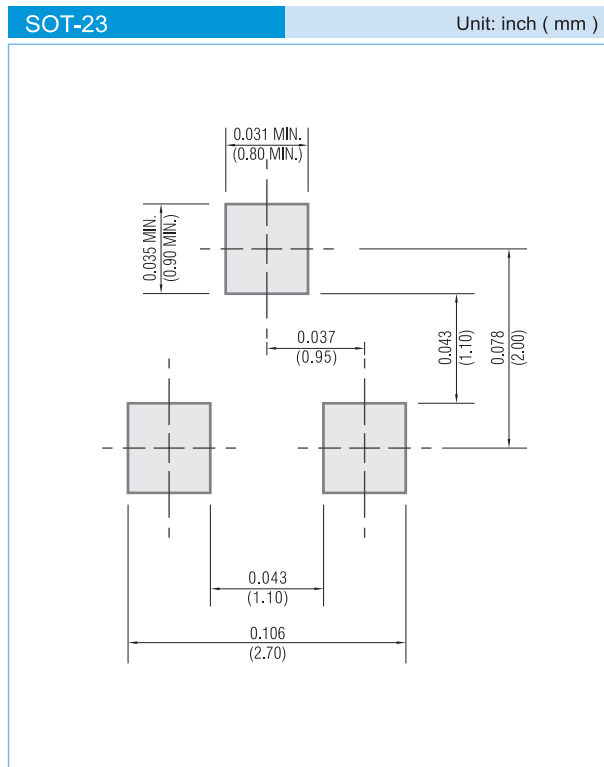

Fig. 5. Typical Capacitances vs. Reverse Voltage



MMBT3906

MOUNTING PAD LAYOUT



ORDER INFORMATION

- Packing information
 - T/R - 12K per 13" plastic Reel
 - T/R - 3K per 7" plastic Reel

LEGAL STATEMENT

Copyright PanJit International, Inc 2008

The information presented in this document is believed to be accurate and reliable. The specifications and information herein are subject to change without notice. Pan Jit makes no warranty, representation or guarantee regarding the suitability of its products for any particular purpose. Pan Jit products are not authorized for use in life support devices or systems. Pan Jit does not convey any license under its patent rights or rights of others.